

Accuphase

STEREO POWER AMPLIFIER

P-1000

- Powerful 11-parallel push-pull output stage delivers linear power into loads as low as 1 ohm
- Current feedback circuit topology combines excellent sound quality with total operation stability
- Bridged connection mode allows upgrading to true monophonic amplifier
- Massive Super Ring toroidal transformer rated for 1.5 kVA
- Printed circuit boards made from Teflon material
- Balanced inputs



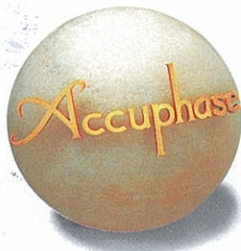

An experience in excellence — Witness a stereo power amplifier capable of delivering 1000 watts into 1-ohm loads. Constant drive voltage principle ensures total speaker control. High-performance power transistors connected in an 11-parallel push-pull configuration deliver linear power even into extremely low impedances. Current feedback topology guarantees stable operation up to ultra high frequencies. Performance specs fully cover the requirements of new-generation program sources such as SACD and DVD-Audio.

The Accuphase monophonic power amplifier M-2000 and the pure class A stereo power amplifier A-50V have been hailed as stunning achievements, both for their outstanding technical performance and impeccable sound quality. While these two models employ somewhat different circuit topology, their underlying philosophy is the same: to provide extremely low output impedance (Note 1), and to be capable of supplying a constant drive voltage at all times (Note 2).

The P-1000 achieves these same goals with even more sophisticated technology. It is a stereo power amplifier that attains yet another dimension of sonic excellence. It is perfect for the new generation of ultra high quality program sources such as SACD and DVD-Audio. Regarding frequency response (0.5 Hz - 160 kHz), S/N ratio, and all other performance aspects, the P-1000 is fully ready for the requirements of the future.

The output uses 11 pairs of high-power transistors in each channel, arranged in a parallel push-pull configuration. These devices are mounted to massive heat sinks that provide efficient dissipation of thermal energy. Power linearity is maintained down to ultra low impedance loads of 1 ohm. By using the P-1000 in bridged mode, the user can create a mono amplifier with even more impressive power reserves. The power supply features a highly efficient "Super Ring" toroidal transformer and large filtering capacitors.

Current feedback topology combines total operation stability with excellent frequency response, while requiring only minimal amounts of negative feedback. Accuphase research has shown that the material used for printed circuit boards has a decisive influence not only on electrical characteristics but also on the sonic end result. The P-1000 uses a Teflon material with extremely low dielectric constant and low loss, resulting in more transparent sound.

The P-1000 is a power amplifier that already impresses by its sheer physical presence. But more importantly, it brings music to life with a dynamic impact and richness of detail that must be heard to be believed.

Note 1 The reasoning for low amplifier output impedance

The load of a power amplifier, namely the loudspeaker, generates a counter electromotive force that can flow back into the amplifier via the NF loop. This phenomenon is influenced by fluctuations in speaker impedance, and interferes with the drive performance of the amplifier. The output impedance of a power amplifier should therefore be made as low as possible by using output devices with high current capability. This absorbs the counter electromotive force generated by the voice coil and prevents the occurrence of intermodulation distortion.

Note 2 The constant drive voltage principle

Even in the presence of a load with wildly fluctuating impedance, the ideal power amplifier should deliver a constant voltage signal to the load. When the supplied voltage remains constant for any impedance, output power will be inversely proportional to the impedance of the load. A conventional amplifier can be easily made to operate in this way down to a load impedance of about 4 ohms. At 1 ohm, however, eight times the output of an 8-ohm load is called for, which can only be sustained by an extremely well designed and capable output stage and a highly robust and powerful power supply section. To build such an amplifier is a task that requires not only considerable experience and resources but also a thorough rethinking of basic principles.

Modular power units in 11-parallel push-pull configuration deliver linear output: 1,000 watts/ch. into 1 ohm, 500 watts/ch. into 2 ohms, 250 watts/ch. into 4 ohms, 125 watts/ch. into 8 ohms

The output stage uses high-power transistors with a rated collector dissipation of 130 watts and collector current of 15 A. These devices have excellent frequency response, current amplification linearity, and switching characteristics. The transistors are arranged in an 11-parallel push-pull configuration (Figure 1) for ultra-low impedance and are mounted on a massive heat sink made from diecast aluminum. This assures effective heat dis-

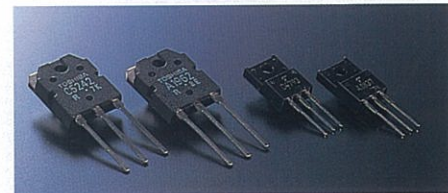

sipation and allows the amplifier to effortlessly handle very low impedances. Power linearity is maintained down to loads as low as 1 ohm, which demonstrates the impressive capabilities of this amplifier.

Figure 2 shows the output/voltage characteristics at various load impedances. It can be seen that output voltage remains nearly constant regardless of load, which means that output current increases linearly.

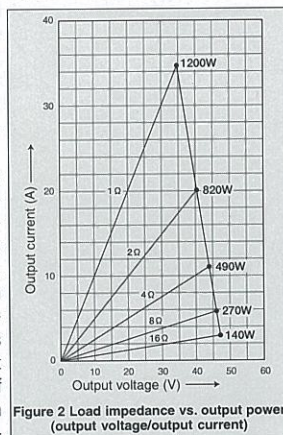

Figure 2 Load impedance vs. output power (output voltage/output current)

Current feedback circuit topology prevents phase shifts

The P-1000 employs the so-called current feedback principle. Figure 3 shows the operating prin-

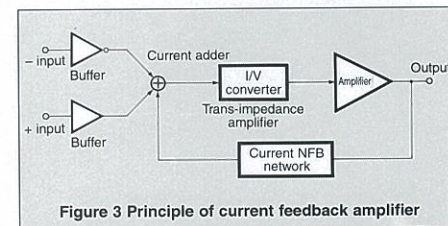

Figure 3 Principle of current feedback amplifier

ciple of this circuit. At the sensing point of the feedback loop, the impedance is kept low and current detection is performed. An impedance-converting amplifier then converts the current into a voltage to be used as the feedback signal. Since the impedance at the current feedback point (current adder in Figure 3) is very low, there is almost no phase shift. Phase compensation can be kept to a minimum, resulting in excellent transient response and superb sonic transparency. Figure 4 shows frequency response for different gain settings of the current feedback

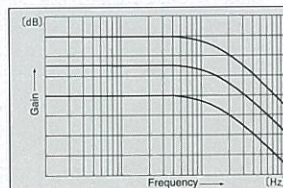

Figure 4 Frequency response with current feedback (response remains uniform also when gain changes)

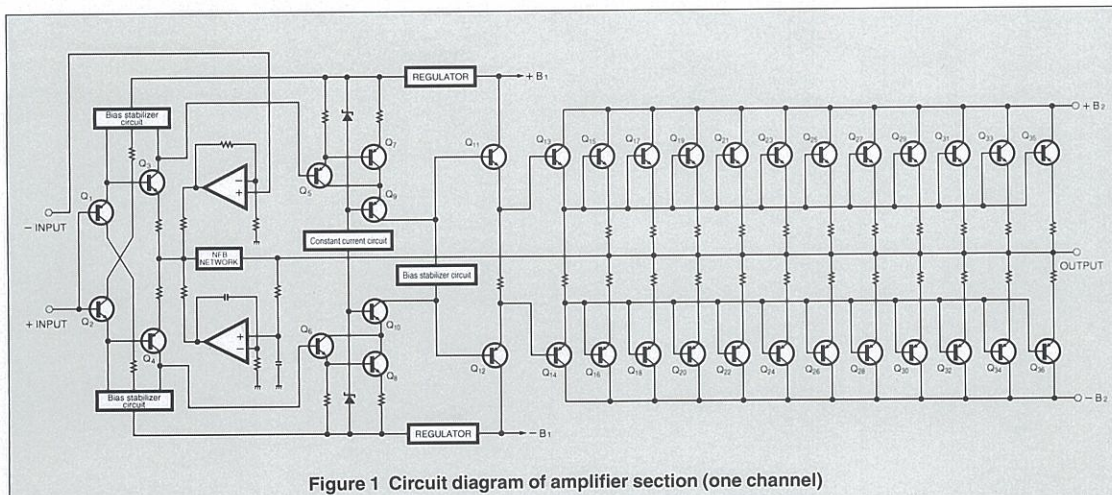

Figure 1 Circuit diagram of amplifier section (one channel)



amplifier. The graphs demonstrate that response remains uniform over a wide range.

Bridged mode creates a true monophonic amplifier with 2000 watts into 2 ohms, 1000 watts into 4 ohms, or 500 watts into 8 ohms

Bridged operation means that two amplifiers are driven by the same signal voltage but with opposite phase. The P-1000 provides a switch arrangement for bridged operation of its two channels, which turns the unit into a high-grade monaural amplifier with even higher output capability.

Printed circuit boards made from Teflon material (glass cloth fluorocarbon resin) with low dielectric constant and low loss

The printed circuit boards consist of a glass cloth fluorocarbon resin material which has a stable, low dielectric constant as well as superior heat resistance and high-frequency characteristics. Since printed circuit boards inevitably act to a certain extent as a dielectric, it is vital to choose a material that provides all the required physical properties while having a low dielectric constant. The low dielectric constant results in speedier signal propagation, and low losses mean further enhanced signal purity. S/N ratio also is excellent.

* Teflon is a registered trademark of DuPont USA.

All major signal paths gold-plated

High-purity copper is commonly used in audio components for signal path lines. The P-1000 goes one step further by providing gold-plating. This includes not only the copper traces on printed circuit boards but also ground bars carrying large ripple currents, bus bars providing current to the power transis-

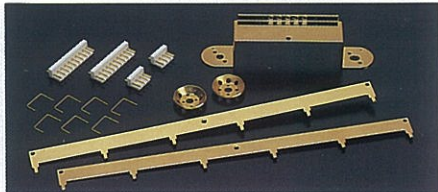

tors, input jacks, and speaker terminals. This thorough approach results in a distinct sonic improvement.

Robust power supply with "Super Ring" toroidal transformer and high filtering capacity

The P-1000 features a large toroidal power transformer with a rating of 1.5 kVA. Toroidal power transformers use heavy-gauge copper wiring on a doughnut-shaped core. This results in low impedance and high efficiency, while allowing compact dimensions. In particular, the "Super Ring" transformer used in the P-1000 has the following advantages:



- ① A near-circular core allows near-circular coil windings with high packing density, resulting in low weight, low losses, low leakage flux under actual load conditions, and minimum vibrations.

- ② Smaller ferrite core diameter and copper windings with high specific gravity mean low ferrite losses and low inrush current.

Two ultra-large aluminum electrolytic capacitors rated for 56,000 µF each provide more than ample filtering capacity and allow the amplifier to effortlessly handle any power demand.



- Power amplifier assembly with Teflon PCB current feedback amplifier circuitry and 11 parallel push-pull transistors per channel mounted directly to large aluminum diecast heat sinks

Extra large speaker terminals

The oversize speaker terminals can accept very heavy-gauge speaker cable. The terminals are made of extruded high-purity brass material and are gold-plated for utmost reliability and minimum contact resistance. Molded caps provide proper insulation.

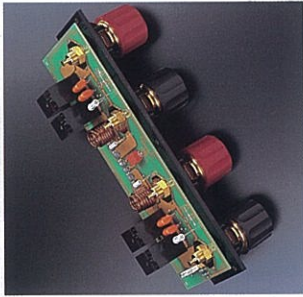

Easy switching between dual mono operation and bridged connection

A mode selector on the rear panel makes it simple to switch between dual mono, stereo, or bridged

operation. The dual mono position is useful, for example, to drive a center woofer in mono, or to obtain the same signal from both speaker outputs for driving a bi-amped speaker setup.



Balanced connection reliably blocks induced noise

Balanced signal transmission means that two signal lines are used which carry the same signal with opposite phase. On the receiving side, the signals are mixed. Since any noise interference that has arisen during transmission will be present in both lines with identical phase, such noise is canceled out, leaving only the pure original signal. Balanced connection therefore keeps the signal transfer free from any kind of interference.

Large direct-reading analog power meters

The large analog power meters have a peak hold function which lets the user easily monitor the output level of the rapidly fluctuating music signal. Thanks to logarithmic compression, the meters cover a wide dynamic range. Switches for meter on/off and illumination are also provided.

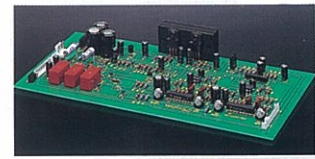

Assembly with meter circuits, protection circuitry, etc.

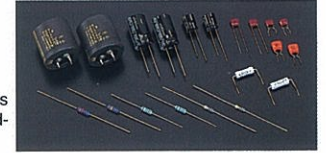

High-quality parts assure outstanding reliability

FRONT PANEL

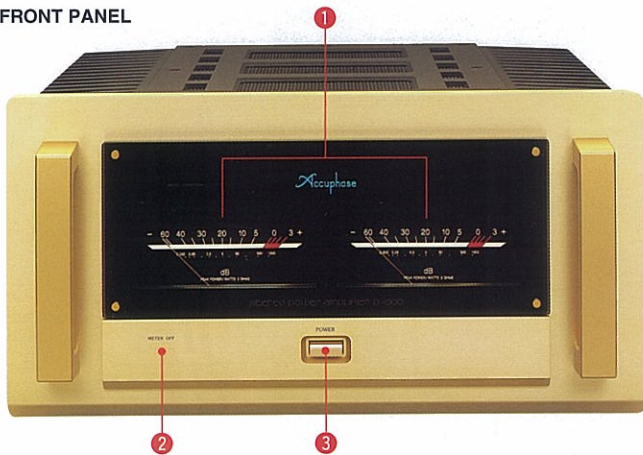

REAR PANEL



- | | |
|---|---|
| <p>1 Peak power meters for left and right channel (dB scale, direct-reading for 2-ohm load)</p> <p>2 Meter operation/illumination switch ON OFF</p> <p>3 Power switch</p> <p>4 Speaker output terminals for left and right channel</p> <p>5 Mode selector
DUAL MONO NORMAL
BRIDGE LEFT BRIDGE RIGHT</p> | <p>6 Unbalanced inputs</p> <p>7 Input selector UNBAL BAL</p> <p>8 Balanced input connectors
① Ground
② Inverted (-)
③ Non-inverted (+)</p> <p>9 AC circuit breaker*</p> <p>10 AC input connector (for supplied power cord)*</p> |
|---|---|

Remarks

- * The P-1000 is available in various models (120 V, 230 V) depending on the destination country and area. Be sure to check that the voltage rating on the rear panel exactly matches the AC line voltage used in your area.
- * The capacity rating and shape of the circuit breaker and the shape of the power plug as well as other aspects may differ for various models.

The performance specifications of existing Accuphase analog amplifiers comply to the playback requirements of new-generation media (SACD and DVD-Audio).

P-1000 Guaranteed Specifications

[Guaranteed specifications are measured according to EIA standard RS-490.]

- **Continuous Average Output Power (20 - 20,000 Hz)**

Stereo operation (both channels driven)	1,000 watts into 1 ohm*
	500 watts into 2 ohms
	250 watts into 4 ohms
	125 watts into 8 ohms
Mono operation (bridged mode)	2,000 watts into 2 ohms*
	1,000 watts into 4 ohms
	500 watts into 8 ohms

Note: Ratings marked * are for music signals only.
- **Total Harmonic Distortion**

Stereo operation (both channels driven)	0.05% with 2 ohm load
	0.03% with 4 to 16 ohm load
Mono operation (bridged mode)	0.03% with 4 to 16 ohm load
- **Intermodulation Distortion** 0.003%
- **Frequency Response**

At rated continuous average output:	20 - 20,000 Hz +0, -0.2 dB
At 1 watt output:	0.5 - 160,000 Hz +0, -3.0 dB
- **Gain** 28.0 dB (stereo/mono operation)
- **Output Load Impedance**

Stereo operation:	2 to 16 ohms
Mono operation:	4 to 16 ohms

* With music signals, load impedances of 1 ohm (stereo) or 2 ohms (mono) can be driven.
- **Damping Factor** 300 (stereo/mono operation)
- **Input Sensitivity (8 ohm load)**

Stereo operation:	1.26 V for rated continuous average output
	0.11 V for 1 watt output
Mono operation:	2.52 V for rated continuous average output
	0.11 V for 1 watt output
- **Input Impedance** Balanced: 40 kilohms, Unbalanced: 20 kilohms
- **Signal-to-Noise Ratio (A-weighted, input shorted)**

114 dB for rated continuous average output
117 dB at clipping point
- **Analog Output Level Meters** Logarithmic compression scale -60 dB to +3 dB and direct watt-reading scale for 2 ohms
- **Power Requirements** 120 V / 230 V (Voltage as indicated on rear panel) AC, 50/60Hz
- **Power Consumption** 148 watts at zero signal input, 1,070 watts in accordance with IEC-65
- **Maximum Dimensions**

Width:	475 mm (18-11/16")
Height:	258 mm (10-3/16")
Depth:	545 mm (21-7/16")
- **Weight**

50 kg (110.2 lbs) net
60 kg (132.2 lbs) in shipping carton

● Specifications and design subject to change without notice for improvements.



PRINTED IN JAPAN F9910Y 851-0161-00 (AD1)